

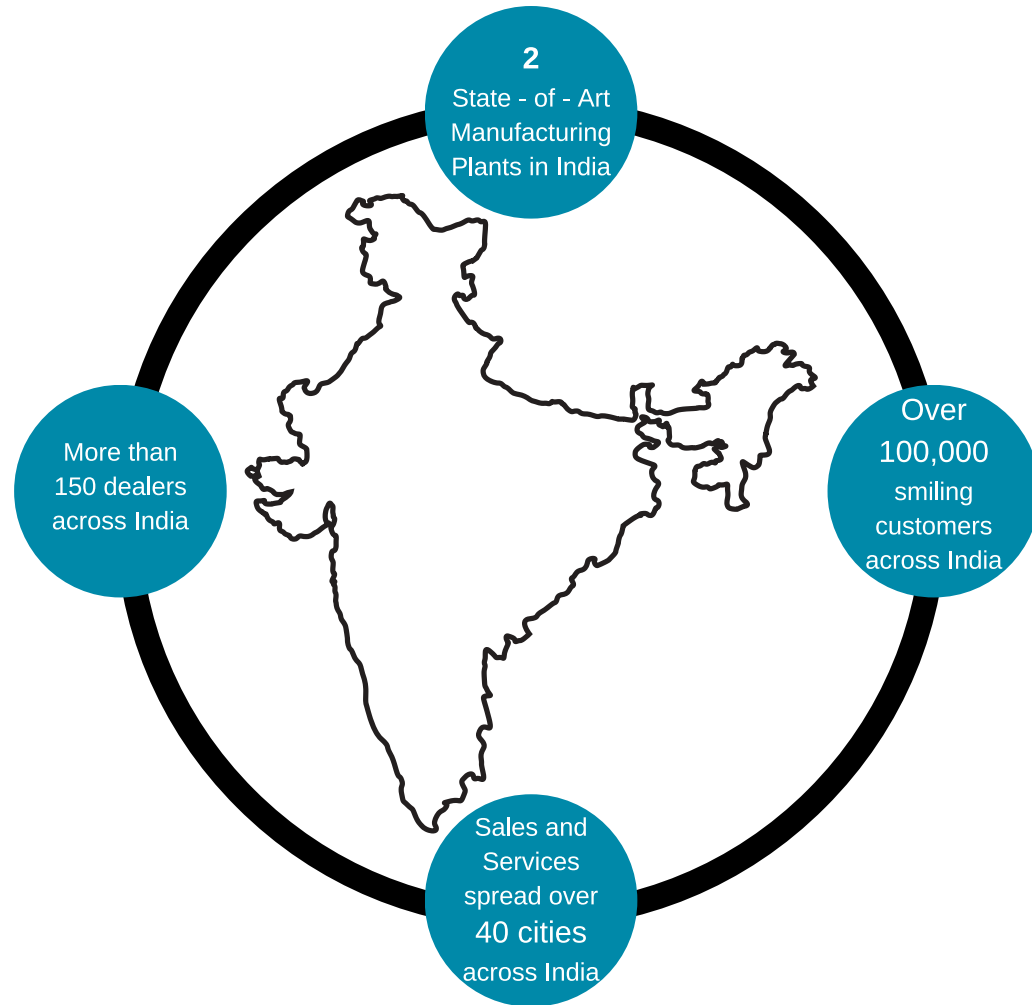

**Active** with Newest Technology



Anest Iwata Motherson Pvt. Ltd.  
 B-123 & 124, Sector-63, Noida - 201301,  
 Distt. Gautam Budh Nagar, UP, India.  
 Website: [anestiwata.motherson.com](http://anestiwata.motherson.com)  
 Email: [anestiwata@aim.motherson.com](mailto:anestiwata@aim.motherson.com)



For any details reach us at:  
 Head Office: +91-120-4600-500/510/512/517  
 North : +91-9910394044 +91-9871362399  
 East : +91-9990023423 +91-9560806653  
 West : +91-9899553648 +91-9850993326  
 South : +91-9940654560 +91-9866000499

AUTHORISED CHANNEL PARTNER



## APM Series High Efficiency Screw Air Compressor Variable Speed Drive

7.5kW - 75kW / 10 - 100 HP  
 High Efficiency Permanent Magnet Drive













*The Air of Trust*

# ABOUT ANEST IWATA MOTHERSON



A joint venture between Anest Iwata Japan and Motherson India, established in the year 2000 for manufacturing air compressors, vacuum pumps, and coating equipment, along with a full variety of coatings automation and robotics system Integration with brilliant after-sales services. The company's long list of satisfied customers from many industrial sectors proves products and service quality. Company constantly develop its innovations to exceed high Japanese standards unmatched by other manufacturers.

 <b>100000m<sup>2</sup></b> Square meters factory	 <b>83</b> Country exported	 <b>50000</b> Global customers
 <b>35</b> Professional certifications	 <b>35</b> Japanese R&D team member	 <b>500</b> Global sales and service agents
 <b>91</b> National patents	 <b>10</b> Industry standards	 <b>20</b> Years of R&D
 <b>8%</b> Annual sales re-invested into R&D	 <b>140000</b> Production volume from 2000	



## A Spirit that Rises to the Challenge, Inherited from the Time of our Founding

Since our founding in 1926, we have been leading the Japanese coating equipment and air compressor industries for many years, developing some of the world's first products. The "ANEST" in the company name, ANEST IWATA, represents our determination to always be "Active with Newest Technology" as a development-oriented company that is consistently vibrant and equipped with innovative technologies. Here, we introduce the fearless spirit of our founders who were always taking on new challenges, passed down to us for generations since our founding.



### Anest Iwata Motherson

Anest Iwata Motherson (AIM) is a joint venture between Anest Iwata Corporation, Japan, and Motherson Group, India. Anest Iwata Corporation is one of the global leaders in Air Compressors and Vacuum Pumps with more than 9 decades of inspiring history of technological excellence.

Anest Iwata Motherson is committed to delighting its customers by ensuring the supply of the best quality products, supported with effective after-sales services at optimum value. The company has two state-of-the-art manufacturing facilities and a wide network of sales and service centers across India.

### Our Global Presence

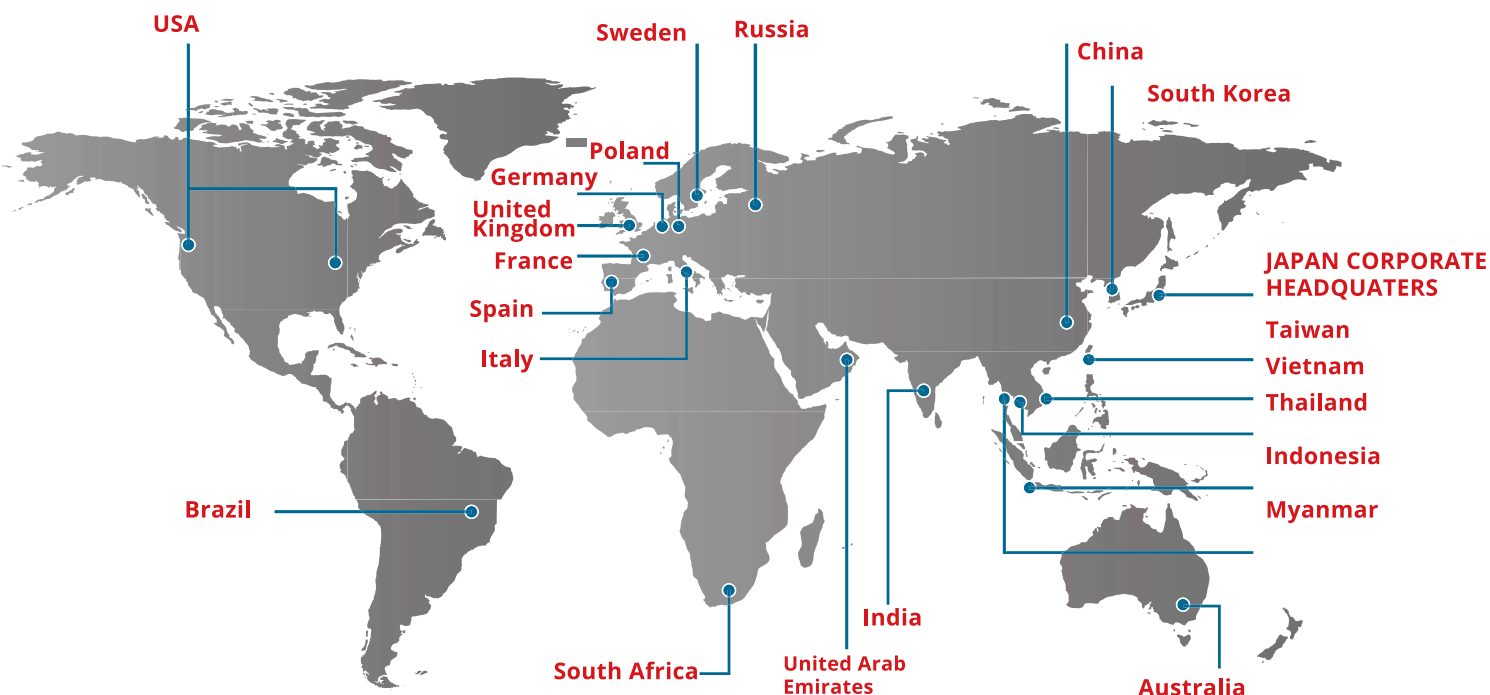

## APM Series



Motor Power



Discharge Airflow



Pressure

Motor Power

Discharge Airflow

Pressure



### Ultimate Energy Efficient Inverter Model

The Anest Iwata Motherson APM range pushes the boundaries of compressed air efficiency once again with its latest generation of APM series screw air compressors. Our APM has class-leading low energy consumption, leading to reduced running costs.

Like all Anest Iwata Motherson compressors, they are both intuitive and maintenance friendly with exceptional versatility and an environmentally responsible design.

Energy saving variable speed control

Wide speed range

Super premium efficiency PM motor

Oversized innovative cooling system

Morse connection design for motor and airen

suitable for use in up to 52°C ambient



## APM SERIES

EVEN MORE EFFICIENT

### 1 Permanent magnet motor

- Reach IE4 efficiency standard
- Lubricant-cooled motor
- VSD: variable speed drive
- IP65 protection

### 2 New compressor airend

- New improved rotor profile
- R&D in Japan
- Designed to give many years of reliable operation

### 3 Inlet filter

- Nano scale heavy duty
- filtration accuracy upto 99.9%
- Dust particles below 0.3 micron
- Pressure drop indicator
- Make the main rotor bearing from attrition
- Extend the service life of the lubricating oil and oil filter

### 4 VSD fan

- VSD control
- Compact
- Low noise level
- High capacity for optimized cooling low power consumption

### 5 Classic cooler design

- Easy access for maintenance
- Paint anti-corrosion coating on surface
- 30% oversized cooler design

### 6 Innovative flux vector inverter

- Wide voltage design
- Meets C3 and C3 EMC requirements
- Built-in DC reactor
- Independent cooling air duct design
- robust enclosure to trouble free operation

### 7 IT 6000 touch PLC

- 7.0 inch full color touch screen
- Real-time operation/ maintenance/ alarm information
- Full graphical flow diagram
- Operation record/ chart display
- Multiple languages
- Weekly and daily scheduling, service history and planning
- On board RS485 interface

### 8 Inlet valve

- Optimizes the inlet flow of the airend
- No blow down losses
- Full aluminum maintenance free design
- High vacuum degree:700mmhg
- Large suction area
- Fast check: prevent unloading and shutdown oil injection
- Fluoro rubber for improved valve seal

### 9 Oil filter

- High efficiency oil filter removes contaminants from the oil
- Oil particles can be controlled at 0.1 micron
- Ensures a smooth and well lubricated oil system

### 10 Gas tank & built-in separation system

- Oversized air and oil tank improves the cyclone effect maximizing the separation process
- The high efficiency oil separator ensures that the oil carry over is less than 3ppm
- system pressure loss is less than 0.02mpa
- The rotating oil tank lid makes maintenance convenient and straight forward reducing maintenance down time(75/100HP)

### 11 All steel internal pipe system

- All steel internal pipe work and compression joints are used to prevents leakage and premature ageing often seen with flexible pipes
- Less pipe friction loss

## Super Premium Efficiency IPM Motor

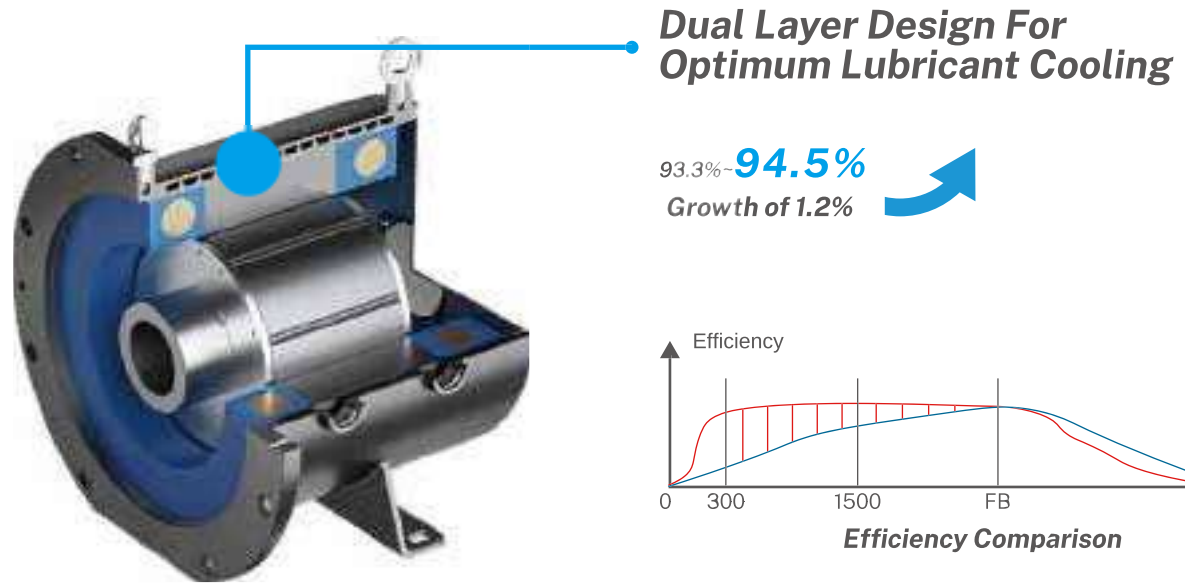

93.3% - **94.5%**  
Growth of 1.2%

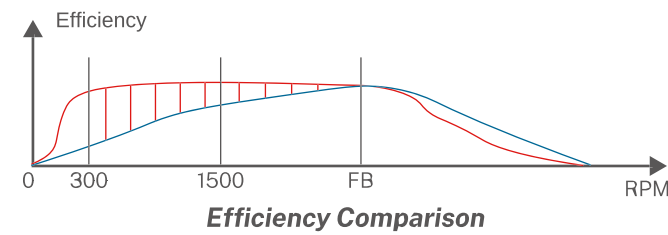

- Oil-cooled motor
- Fully enclosed IP65 protection
- Reach IE4 efficiency standard
- VSD: variable speed drive
- Optimal cooling for all speeds and ambient conditions
- Bearing free motor requires zero maintenance
- UH series permanent magnets resist to 180°C
- F-grade insulation and B-grade temperature rise assessment
- High-temperature design prevents demagnetization

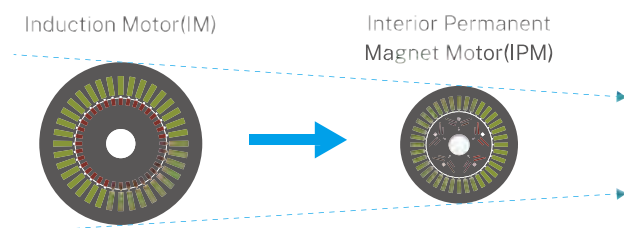

Example: 75KW 380V | Volume 37% | Weight 26%

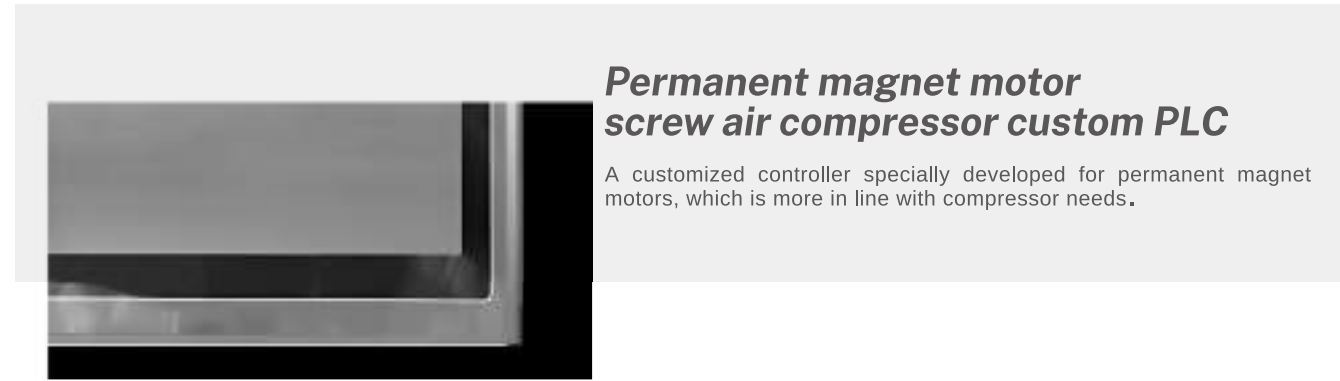

## Pure Soft-start System As Standard

### Soft Start System Reduces The Electric Current During Start Up

Anest Iwata Mothers APM Series adopts a soft start system for its start-up. The Inovance VSD maintains full load current on start up to 1.5 times FLC- Traditional motor starters such as direct on line starters and star delta starters burden the power supply due to the high peak start up current which can typically be 8-10 times FLC. With a variable speed soft start system, the starting current never exceeds the rated value.

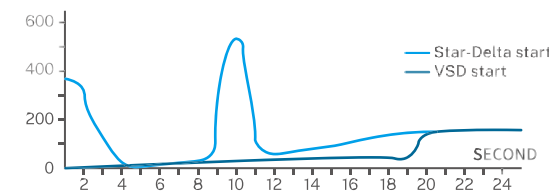

### Seven major characteristics

- On Board RS485 communication
- Intelligent PID flow regulation mode
- Accurate torque control
- Fast response speed for system pressure
- Fast acceleration and deceleration characteristics
- Closed loop dynamic and high precision control
- Constant pressure control avoids over generating site air pressure



## AIM Heavy Duty Air Filter

The heavy-duty air filter is carefully designed to be suitable for medium and heavy dust load environmental conditions.



- On the basis of the ordinary air filter, it adds a centrifugal separation structure design on the one hand, so that the air entering the air filter element is pre-separated to remove larger particles of dust, thereby effectively extending the service life and maintenance cycle of the filter element.
- On the other hand, the structure of the filter paper is improved to increase its ash capacity, and there is a special design between the fold layers to prevent damage to the bond. It can effectively filter dust and impurities in harsh operating environments such as high dust and high impurities, extend the service life of the air filter element, and protect the host and the oil and gas pipeline system.

## 30% Oversized Cooler design

Oversized cooler makes sure the compressor can run max. up to 52 degree without any problem



## Cyclone oil tank design ensures the high separation efficiency

- The first stage is mechanical centrifugal separation
- The second stage is high efficiency oil separator
- 4000 hours life-span of oil separator
- The oil content is lower than 3PPM

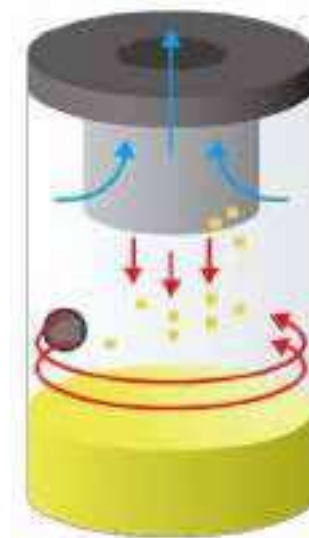

## Gas tank & built-in separation system

- The flow guide plate changes flow direction, and the cross collision makes the small oil particles combine into large oil particles to separate, reduce the burden on the oil gas separator layer, and extend the life of oil separator
- Reserved more than 30% margin of oil separator



## Innovation For Efficiency

- High efficiency Airend profile, specially designed for this PM motor application optimizes the compressor efficiency
- Original world famous bearing brand from SKF or TIMKEN or FAG

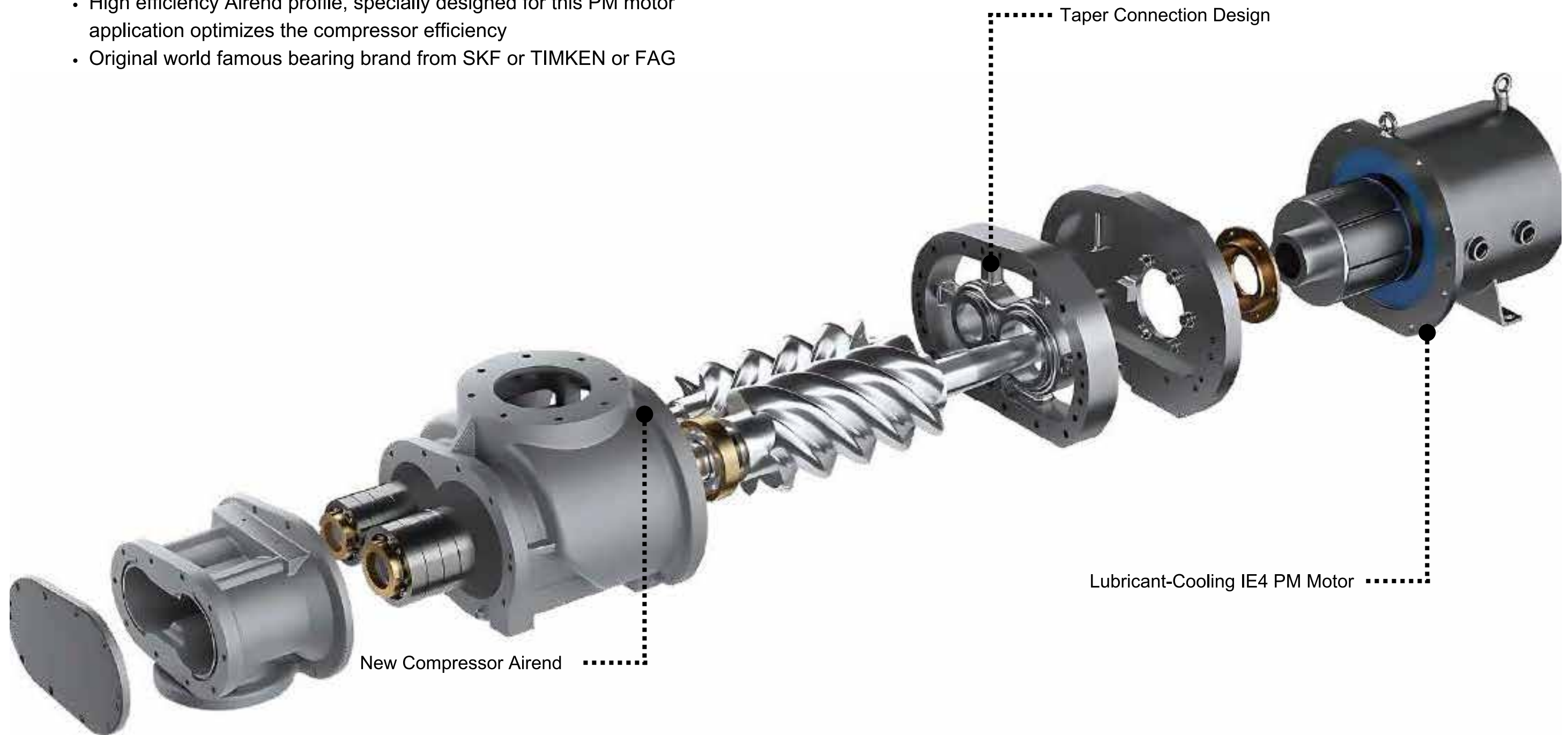

# Technical Specification

Model	kW	HP	FAD (m3/min)	CFM	Pressure (Bar)	Noise Level (dB)	Dimensions (mm)	Outlet size	Weight (kg)
AIM 10 APM - 7	7.5	10	1.15	16-41	7	64	750 x 650 x 890	RC 1/2	230
AIM 10 APM - 8			1.10	16-39	8				
AIM 10 APM - 10			0.95	21-34	10				
AIM 15 APM - 7	11	15	1.75	26-62	7	64	900 x 800 x 1053	RC 3/4	270
AIM 15 APM - 8			1.70	25-60	8				
AIM 15 APM - 10			1.50	27-53	10				
AIM 15 APM - 13			1.20	23-43	13				
AIM 15 APM - 15			1.00	20-36	15				
AIM 20 APM - 7	15	20	2.40	32-85	7	68	900 x 800 x 1053	RC 3/4	280
AIM 20 APM - 8			2.30	31-82	8				
AIM 20 APM - 10			2.00	36-71	10				
AIM 20 APM - 13			1.60	26-57	13				
AIM 20 APM - 15			1.30	25-46	15				
AIM 20 APM - 16			1.20	25-43	16				
AIM 30 APM - 7	22	30	3.70	31-131	7	70	1200 x 800 x 1100	RC 1	350
AIM 30 APM - 8			3.60	31-128	8				
AIM 30 APM - 10			3.00	27-107	10				
AIM 30 APM - 12.5			2.70	23-96	12.5				
AIM 30 APM - 15			1.90	32-68	15				
AIM 30 APM - 16			1.80	31-64	16				
AIM 40 APM - 7	30	40	4.7	40-165	7	71	1200 x 800 x 1100	RC 1 1/2	520
AIM 40 APM - 8			4.6	39-162	8				
AIM 40 APM - 10			4.2	35-148	10				
AIM 50 APM - 7	37	50	6.20	53-220	7	74	1300 x 900 x 1270	R 1 1/2	620
AIM 50 APM - 8			6.10	53-216	8				
AIM 50 APM - 10			5.60	46-198	10				
AIM 60 APM - 7	45	60	7.40	66-262	7	73	1300 x 950 x 1370	RC 2	1000
AIM 60 APM - 8			7.30	66-258	8				
AIM 60 APM - 10			6.80	59-241	10				
AIM 75 APM - 7	55	75	10.4	92-368	7	77	1800 x 1200 x 1550	RC 2	1100
AIM 75 APM - 8			10.1	89-357	8				
AIM 75 APM - 10			8.50	75-301	10				
AIM 100 APM - 7	75	100	13.3	106-471	7	77	1800 x 1200 x 1550		
AIM 100 APM - 8			12.9	103-456	8				
AIM 100 APM - 10			11.8	92-418	10				

- Note :
- Standard Voltage is 400V/50Hz
  - Free Air Delivery (m /min / cfm) is measured as per ISO 1217: 2009 - Annex C
  - Mean noise level measured at a distance of 1 m according to ISO 2151: 2004 using ISO 9614/2 (sound intensity method); tolerance 3 dB(A).
  - All performance parameters are as per JIS (Japanese Industrial Standards)
  - Vertical Air Tanks are available from 500 to 5000 liters
  - Standalone Refrigerated Air Dryers, Heatless Air Dryers, Oil Removal Filters, and Auto Drain Valves are also available
  - Specifications may change without prior notice

## Tank Mounted With Dryer

Model	kW	HP	FAD (m3/min)	CFM	Pressure (Bar)	Noise Level (dB)	Dimensions (mm)	Outlet size	Weight (kg)	Tank Size
AIM10APM-7-TD-28	7.5	10	0.45-1.15	16-41	7	64	1600x750x1510	3/4"	430	280
AIM10APM-8-TD-28			0.43-1.10	16-39	8					
AIM10APM-10-TD-28			0.57-0.95	21-34	10					
AIM10APM-7-TD-50	7.5	10	0.45-1.15	16-41	7	64	1910x860x1600	3/4"	500	500
AIM10APM-8-TD-50			0.43-1.10	16-39	8					
AIM10APM-10-TD-50			0.57-0.95	21-34	10					
AIM15APM-7-TD-50	11	15	0.72-1.75	26-62	7	64	1910x1000x1770	1"	560	500
AIM15APM-8-TD-50			0.69-1.70	25-60	8					
AIM15APM-10-TD-50			0.75-1.50	27-53	10					
AIM20APM-7-TD-50	15	20	0.9-2.40	32-85	7	68	1910x1000x1770	1-1/2"	570	500
AIM20APM-8-TD-50			0.85-2.30	31-82	8					
AIM20APM-10-TD-50			1.0-2.00	36-71	10					
AIM30APM-7-TD-50			0.9-3.45	32-122	7	70	2000x950x1820	1-1/2"	700	500
AIM30APM-8-TD-50			0.85-2.3	30-120	8					
AIM30APM-10-TD-50			1.0-2.0	25-106	10					

## Tank Mounted

Model	kW	HP	FAD (m3/min)	CFM	Pressure (Bar)	Noise Level (dB)	Dimensions (mm)	Outlet size	Weight (kg)	Tank Size
AIM10APM-7-T-28	7.5	10	0.45-1.15	16-41	7	64	1600x750x1510	1"	375	280
AIM10APM-8-T-28			0.43-1.10	16-39	8					
AIM10APM-10-T-28			0.57-0.95	21-34	10					
AIM10APM-7-T-50	7.5	10	0.45-1.15	16-41	7	64	1910x860x1600	1"	436	500
AIM10APM-8-T-50			0.43-1.10	16-39	8					
AIM10APM-10-T-50			0.57-0.95	21-34	10					
AIM15APM-7-T-50	11	15	0.72-1.75	26-62	7	64	1910x1000x1770	1"	476	500
AIM15APM-8-T-50			0.69-1.70	25-60	8					
AIM15APM-10-T-50			0.75-1.50	27-53	10					
AIM20APM-7-T-50	15	20	0.9-2.40	32-85	7	68	1910x1000x1770	1"	486	500
AIM20APM-8-T-50			0.85-2.30	31-82	8					
AIM20APM-10-T-50			1.0-2.00	36-71	10					
AIM30APM-7-T-50	22	30	0.9-3.45	32-122	7	70	2000x800x1770	1-1/2"	595	500
AIM30APM-8-T-50			0.85-2.3	30-120	8					
AIM30APM-10-T-50			1.0-2.0	25-106	10					